











SWIWIN SW60B

Technical specifications



SWIWIN SW60B List of engine accessories

serial number	name	Picture specification	quantity
1	Engine body		1 set
2	ECU (V3)		one
3	GSU		one
4	Fixing frame		one
5	Brushless oil pump		one
6	Power line		one
7	Signal line		one

8	Throttle line		one
9	Switch valve		one
10	Filter		one
11	Tubing		one

Technical parameter

model	SW60B
Thrust	6kg
Diameter (mm)	83mm
Length (mm)	200mm
weight	800g
ECU weight	42g
usage temperature	-40°C~50°C
supply voltage	3S Lipo battery
starting system	One-button electronic start
Rpm Range	50000-150000
Exhaust Temperature	750°C
Fuel Consumption	200g/min
fuel	kerosene
lube oil	3%~5%
Maintenance Interval	25H

Engine start parameters

Pump Voltage	0.6-0.9V
RPM Start Up Ramp	100%
Pump Start Up Ramp	3
Glow Plug	5-7V
Valve	40
Ignition RPM	6000
Preheat RPM	10000
RPM Off Starter	28000

Engine operating parameters

RPM ACC	15
RPM DEC	15
Max RPM	150000
Idle RPM	50000
Minimum speed	35000
Max Temp	1000
Low Volt	10V
Restart	close
Restart Glow Plug	Consistent with the voltage of the burner
Pump Limit	11V
Idle Stable	5-8

Engine cooling parameters

cool	5000rpm
------	---------

Starting motor parameters

Pop-up time	0.5S
Ejection voltage	4V
Run Voltage	3.5V
RPM Stable	50

Note: All data are measured at standard air pressure.

System connection diagram

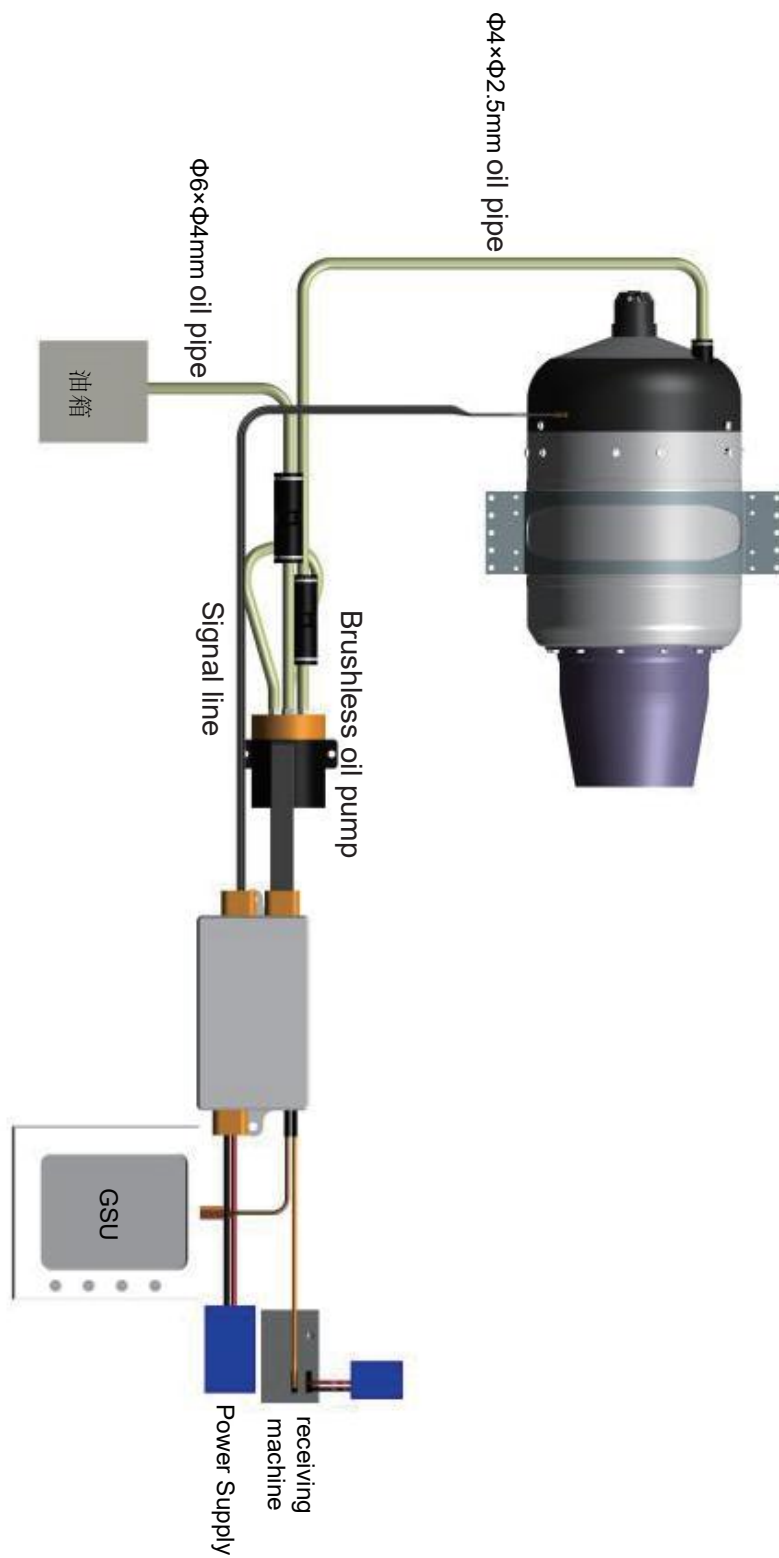

Product dimension diagram

