











# SWIWIN SW120B

## Technical specifications



## SWIWIN SW120B List of engine accessories

serial number	name	Picture specification	quantity
1	Engine body		1 set
2	ECU (V3)		one
3	GSU		one
4	Fixing frame		one
5	Brushless oil pump		one
6	Power line		one
7	Signal line		one

8	Throttle line		one
9	Switch valve		one
10	Filter		one
11	Tubing		one

## Technical parameter

model	SW120B
Thrust	12kg
Diameter (mm)	99.4mm
Length (mm)	241mm
weight	1280g
ECU weight	42g
usage temperature	-40°C~50°C
supply voltage	3S Lipo battery
starting system	One-button electronic start
Rpm Range	50000-125000
Exhaust Temperature	750°C
Fuel Consumption	350g/min
fuel	kerosene
lube oil	3%~5%
Maintenance Interval	25H

## Engine start parameters

Pump Voltage	0.7-1V
RPM Start Up Ramp	100%
Pump Start Up Ramp	3
Glow Plug	5-7V
Valve	20
Ignition RPM	4000
Preheat RPM	6000
RPM Off Starter	25000

## Engine operating parameters

RPM ACC	25
RPM DEC	25
Max RPM	125000
Idle RPM	38000
Minimum speed	33000
Max Temp	1000
Low Volt	10V
Restart	close
Restart Glow Plug	Consistent with the voltage of the burner
Pump Limit	11V
Idle Stable	5-8

## Engine cooling parameters

cool

5000rpm

---

## Starting motor parameters

Pop-up time	0.5S
Ejection voltage	4V
Run Voltage	4V
RPM Stable	50

Note: All data are measured at standard air pressure.

## System connection diagram

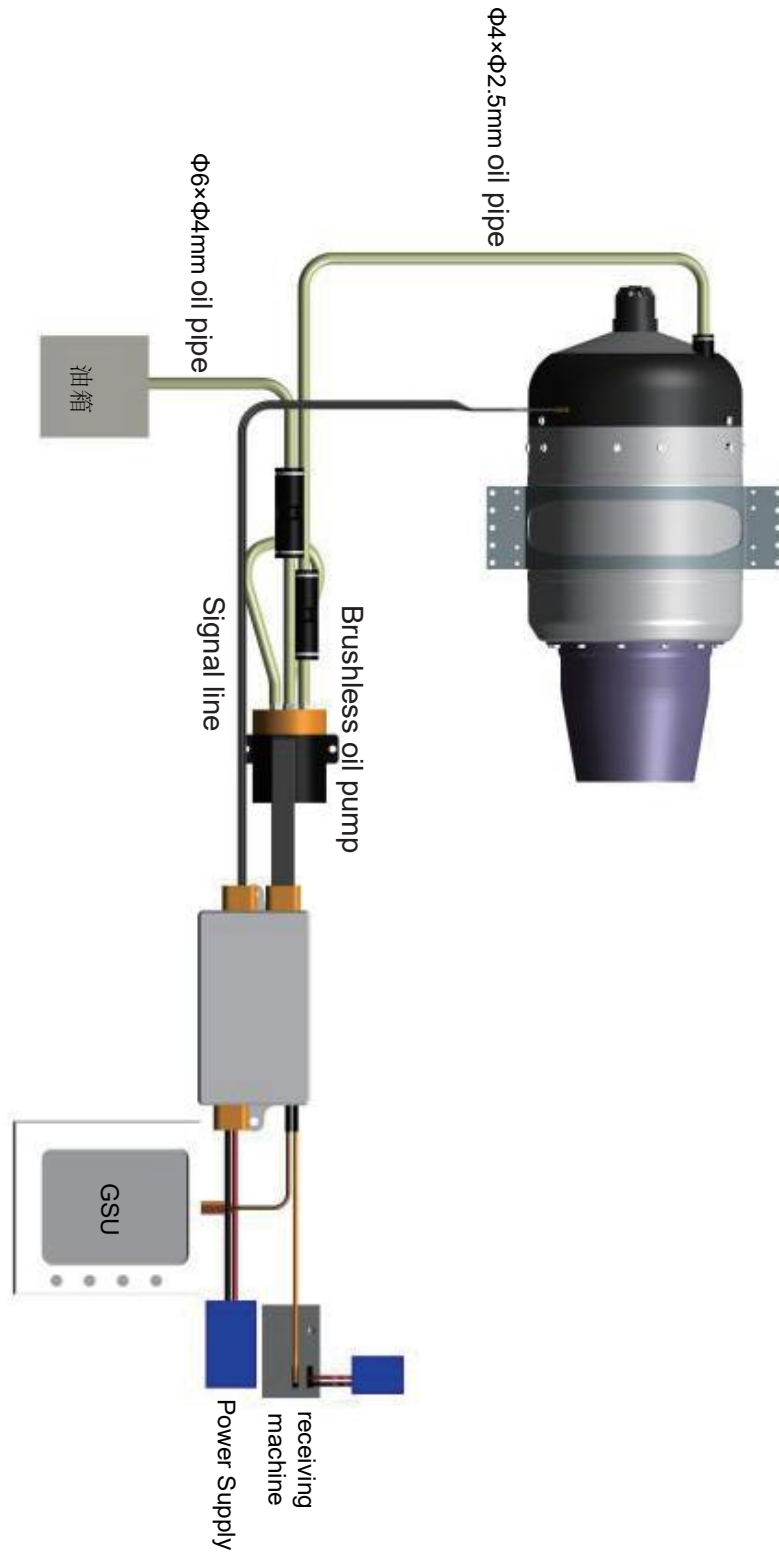

## Product dimension diagram

