

***SWIWIN SW800PRO-Y ENGINE  
TECHNICAL MANUAL***



*you and us*

*welcome to the age of turbojet models! swiwin is ready to take you to experience different flight fun!*

*firstly, please carefully read this manual to have a comprehensive understanding and impression of the engine, engine components, and operating process, in order to ensure the safe operation and optimal performance of the engine.*

*this manual will introduce you to how to install, operate, and maintain the engine. if you still have any questions, please feel free to contact us. we will wholeheartedly provide you with sales, technical, and after-sales support services for the swiwin sw800pro-y engine. this instruction manual aims to provide users with detailed usage guidelines and recommendations to ensure the safety of the engine operation and optimal performance.*



## CATALOGUE

<b>1.PRODUCT OVERVIEW.....</b>	<b>3</b>
<b>2.PRODUCT SPECIFICATIONS.....</b>	<b>4</b>
2.1 DIMENSIONAL DRAWING.....	4
2.2 BASIC PARAMETERS OF ENGINE.....	4
2.3 PARAMETERS OF ENGINE OPERATION CONTROL.....	5
<b>3. SAFETY INSTRUCTIONS.....</b>	<b>6</b>
<b>4. INSTALLATION AND DEBUGGING.....</b>	<b>8</b>
<b>5. ENGINE USAGE INSTRUCTIONS.....</b>	<b>9</b>
5.1 LIST OF ENGINE ACCESSORIES.....	9
5.2 ENGINE CONNECTION.....	10
5.3DEFINITION OF PIN CORRESPONDING INTERFACE.....	12
5.4REGARDING THE CONTROL PROTOCOL.....	13
5.5 ENGINE CONNECTION INSTRUCTIONS FOR DIFFERENT STARTING MODES.....	14
6. GSU USER MANUAL.....	17
<b>6. ENGINE DEBUGGING.....</b>	<b>27</b>
6.1 ENGINE ASSEMBLY.....	27
6.2 REQUIREMENTS FOR VENUE AND FACILITIES.....	27
6.3 ENGINE INSTALLATION.....	29
6.4 PRE STARTUP TESTING.....	29

6.5 SAFETY.....	29
6.6 ENGINE OPERATION PROCESS DIAGRAM.....	30
<b>7.PARAMETERS RELATED TO ENGINE STARTUP AND OPERATION.....</b>	<b>31</b>
<b>8.FREQUENTLY ASKED QUESTIONS.....</b>	<b>32</b>
8.1COMMON PROBLEM ELIMINATION.....	32
8.2 ECU ERROR FAULT ANALYSIS.....	36
<b>9. COMPATIBILITY.....</b>	<b>37</b>
9.1 COMPATIBILITY OF SERIAL PORT ADAPTER CABLE CONNECTORS.....	37
9.2 UPGRADER COMPATIBILITY.....	37
<b>10. STORAGE AND LUBRICATION.....</b>	<b>38</b>
<b>11. ENGINE MAINTENANCE AND UPKEEP.....</b>	<b>38</b>
<b>12. AFTER SALES SERVICE.....</b>	<b>39</b>

## 1.PRODUCT OVERVIEW

*as a new type of high thrust turbojet engine, sw800pro-y has advantages such as flameout restart, 5000 meter low-temperature start, high ceiling, and high thrust to weight ratio, providing users with a better experience.*

ELECTRONIC COMPONENTS INTEGRATED WITHIN THE ENGINE BODY:

- brushless starter motor*
- ignition head*
- temperature sensor*



## 2.PRODUCT SPECIFICATIONS

### 2.1 DIMENSIONAL DRAWING

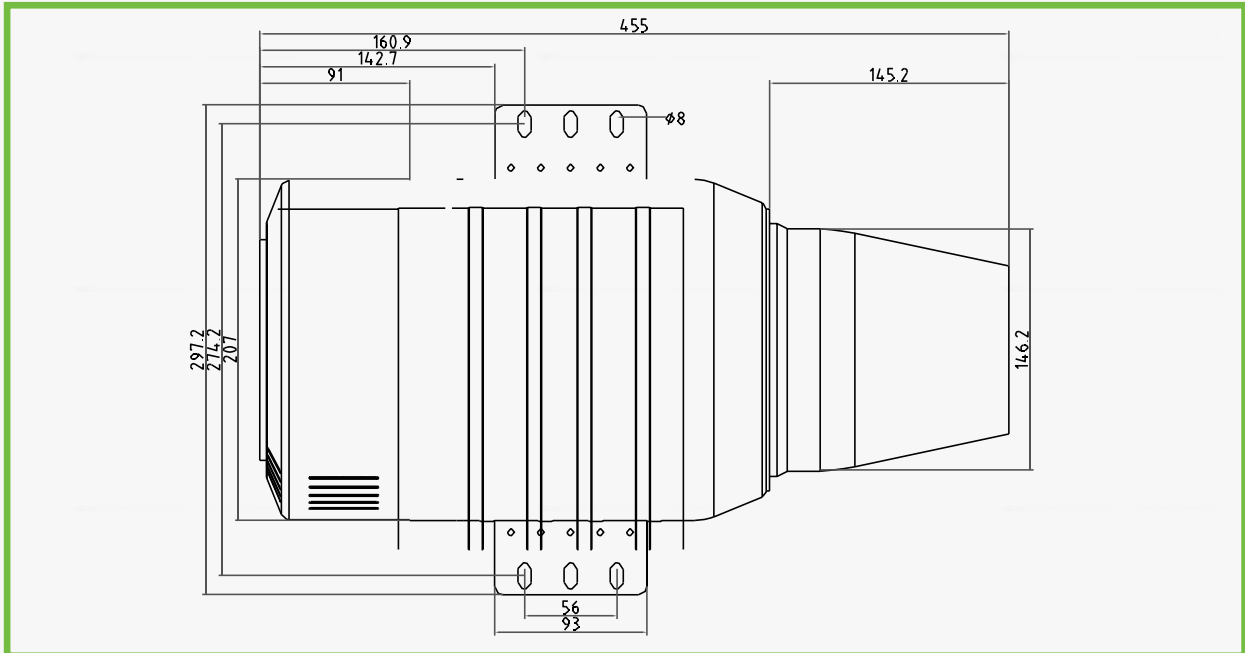

### 2.2 BASIC PARAMETERS OF ENGINE

PROJECT	PARAMETER
model	SW800Pro-Y
thrust	80kg
diameter (mm)	207mm
length (mm)	455mm
weight	9500g
usage temperature	-40℃~50℃
max usable height	12000m
maxi longitudinal overload during catapult takeoff	20g
max allowable flight speed	300m/s

supply voltage	18v-32v
starting system	one key electronic start
rpm range	25,000-65,000
exhaust temperature	750°C
fuel consumption	1850g/min
fuel	aviation kerosene
lube oil	3%-5%
maintenance Interval	25h/time

### 2.3 PARAMETERS OF ENGINE OPERATION CONTROL

PROJECT	PARAMETER
pump voltage	0.7V-0.9V
rpm start up ramp	100%
pump start up ramp	3
glow plug	6.6V
valve	40
ignition rpm	1,300 rpm
preheat rpm	3,000 rpm
rpm off starter	13,000 rpm
rpm acc	10
rpm dec	10
max rpm	65,000 rpm
idle rpm	25,000 min
minimum speed	20,000 rpm
max temp	1000°C

low volt	10.0v
restart	close
restart glow plug	same voltage as the ignition head
pump limit	28V
idle stable	5-8
pop-up time	0.8s
ejection voltage	5V
run voltage	2.5V
rpm stable	20
cool	2,000 rpm

*note: all the data were measured under the standard air pressure*

### **3. SAFETY INSTRUCTIONS**

*safety notice:*

*thank you for using the swiwin micro turbojet engine. the working state of the turbojet engine is essentially highly extreme mechanical work, which poses a certain degree of danger. the operator must be familiar with the operating points and recognize the risks before use. careless operation can easily cause damage to the turbojet body and personal injury. please carefully read the operating instructions in the manual and strictly follow the operating regulations. if this is your first time operating a turbojet engine, please learn how to operate it under the guidance of experienced personnel. before starting the turbojet engine for the first time, please carefully read this manual.*

*safe distance:*

*the engine operates at extremely high rotational speeds. when the engine is running, it must maintain a safe distance from the aircraft, with a distance of 5 meters in front of the engine and 40 meters on both sides.*



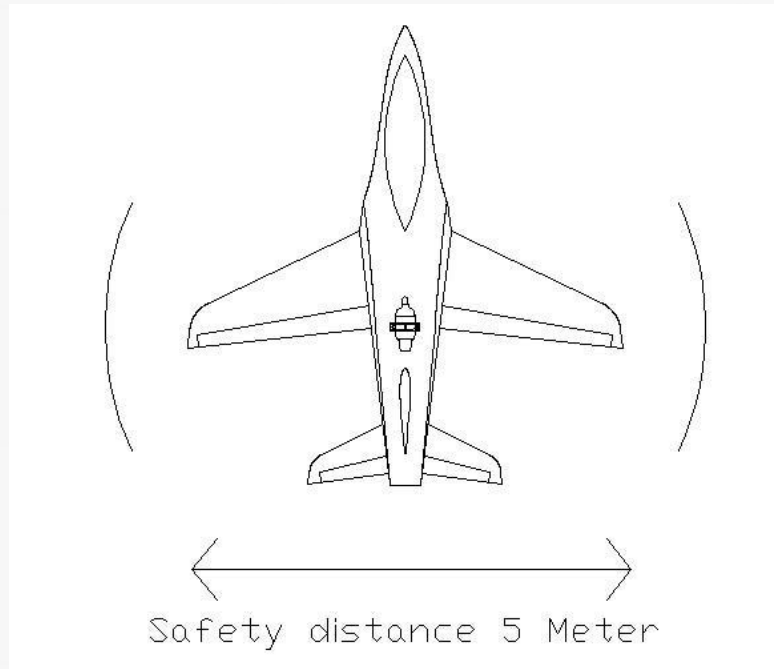

**THE HAZARDOUS AREAS DURING ENGINE OPERATION ARE SHOWN IN THE FOLLOWING FIGURE**

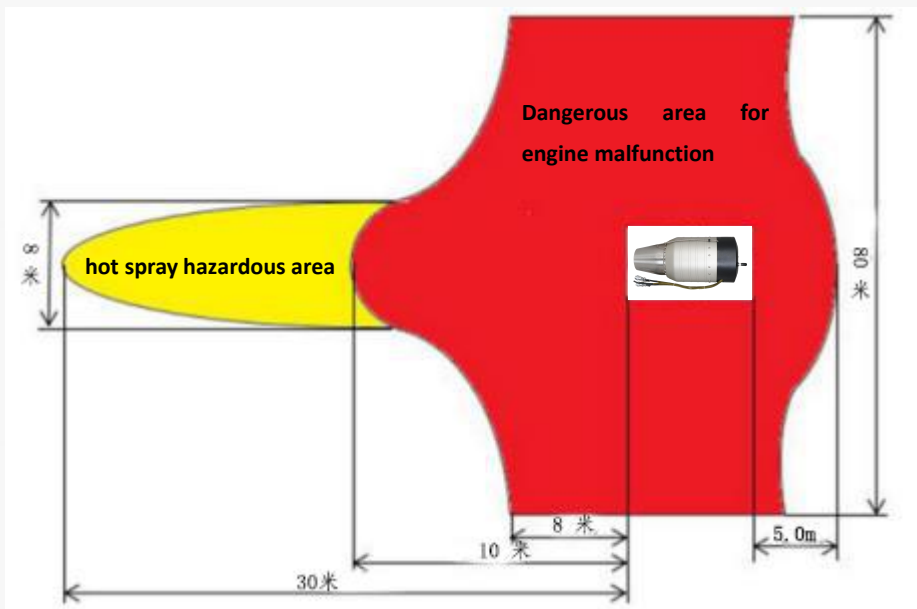

*The SW800Pro engine uses the simplest structure to achieve the most extreme working state, with each component designed and produced to perfection. Do not disassemble the*

intake and main shaft structure without authorization. Once the engine is disassembled, it must be reinstalled with precision according to specifications to achieve its original performance. Improper installation may cause serious safety hazards! Therefore, when your engine needs to be disassembled and repaired, please log in to the swiwin official website and contact after-sales personnel.

- 1) please ensure that there are no personnel involved in the operation process in these hazardous areas, and be familiar with safety precautions before starting the engine. be sure to wear safety equipment (earmuffs, gloves, helmets, etc.) when operating a jet engine
- 2) ensure that there are no components or foreign objects in the intake area that may be compressed and sucked into the intake port! because the engine will produce a large suction force! keep your fingers away from the air intake! do not rotate the pressure wheel with your fingers!
- 3) ensure that there is fire extinguishing equipment (containing at least 5 kilograms of carbon dioxide fire extinguisher).

## 4. INSTALLATION AND DEBUGGING

### SWIWIN SW800PRO ENGINE INSTALLATION FIXED ENGINE

The model version engine is equipped with dedicated fixing clamps. Before operating the engine, the clamp has already been installed on the engine. You only need to fix the clamp on the test bench. Pay attention to the optimal installation position of the engine: rotate the engine to make the oil inlet at the 12 o'clock position.





Fixed bracket



## 5. ENGINE USAGE INSTRUCTIONS

### 5.1 LIST OF ENGINE ACCESSORIES

open the package, the list of engine accessories is as follows

 <p>Engine body</p>	 <p>GSU</p>	 <p>Connector</p>	 <p>RS232 serial port</p>
 <p>Fixed Bracket</p>	 <p>Upgrade Tool (One to Two)</p>	 <p>Power cable</p>	
 <p>Power Plug K2</p>	 <p>Signal plug k7</p>	 <p>Tubing</p>	

## 5.2 ENGINE CONNECTION

*open the packaging, familiarize yourself with each component, and connect them as shown in the following diagram. (receiver, battery, remote control, and computer need to be provided by oneself)*

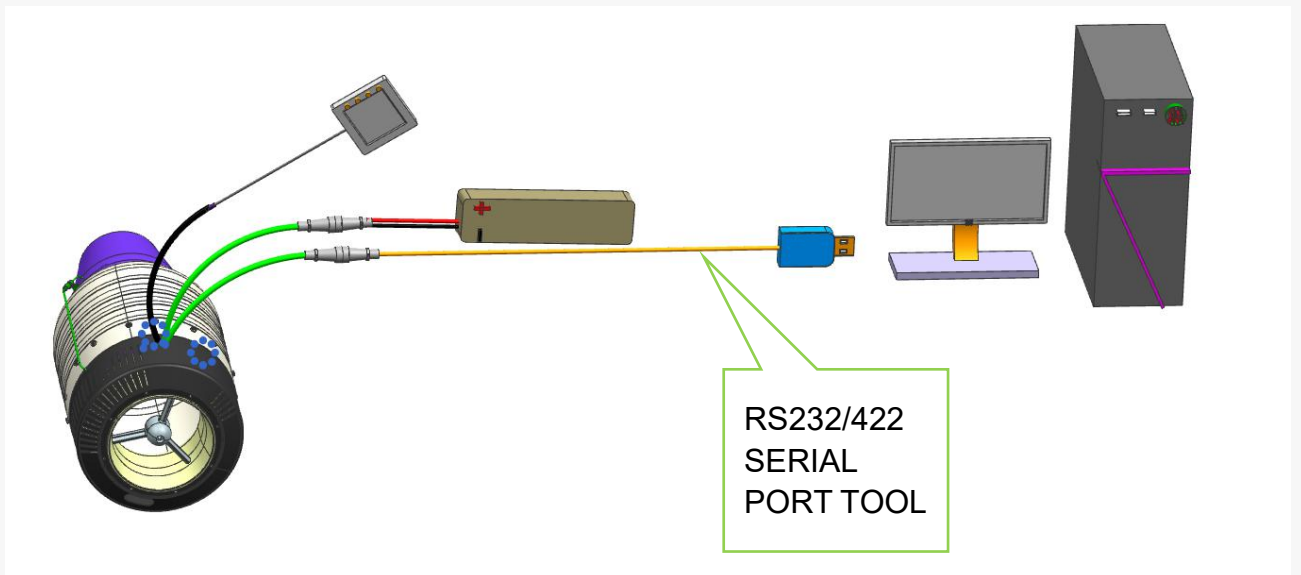
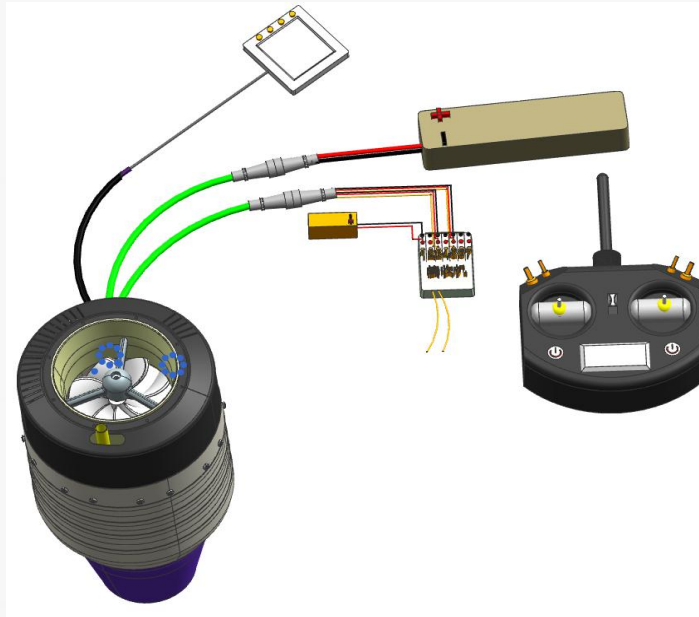



*the sw800pro-y engine is mainly composed of the engine body, fuel control system, and five major electrical components*

*engine body:*

*the engine body includes the stator system (diffuser, shaft tube, combustion chamber, nozzle ring, hardened intake port, etc.), rotor system (impeller, main shaft, inlet bearing, rear turbine, etc.), and all components are tightly matched with high precision.*

*start the system:*

*the engine uses a self-developed brushless starter motor, which can achieve more stable, smooth, energy-saving, and extended service life compared to traditional motors. the startup system also has a power generation function. the starter motor starts working, and the engine starts generating electricity. after the engine enters idle, the ecu will turn off the external input power supply to achieve autonomous power supply.*

*oil pump:*

*the sw800pro-y engine adopts an integrated oil control system design, which integrates the main oil pump, starting oil pump, solenoid valve, and oil filter on the valve body, making it the easiest installation state for the engine. equipped with a built-in oil filter, it effectively prevents engine failure caused by fuel system blockage.*

*solenoid valve:*

*the solenoid valve includes two oil passages, one for the main fuel line and one for the ignition injector line.*

*control system:*

*adopting the ecu-tcu integrated electronic control system independently developed by the company, using a 32-bit high-speed chip, it has the functions of automatic shutdown and restart, multiple function protection, and the matching gsu is a color display screen. it has many advantages such as software upgradability, precise speed control, and rapid throttle response.*

*oil system*

*the fuel enters the engine through the anti bubble fuel tank and first passes through an internal oil filter with a filtering accuracy of 15 microns to prevent the oil pump from stalling due to impurities and causing engine failure. after filtering, the fuel enters the solenoid valve through the oil pump and connecting pipe, and is divided into two parts, one part enters the ignition oil circuit and the other part enters the main oil circuit. after successful ignition, the ignition solenoid valve automatically closes. the fuel entering the main oil circuit enters the combustion chamber through the inlet pipe and oil system for combustion and work.*

*ignition system*

*the sw800pro-y engine adopts dual atomizing nozzles combined with specially designed dual ignition heads, which have the advantages of fast ignition speed and high efficiency.*

**5.3 DEFINITION OF PIN CORRESPONDING INTERFACE**

**DEFINITION OF POWER INTERFACE**

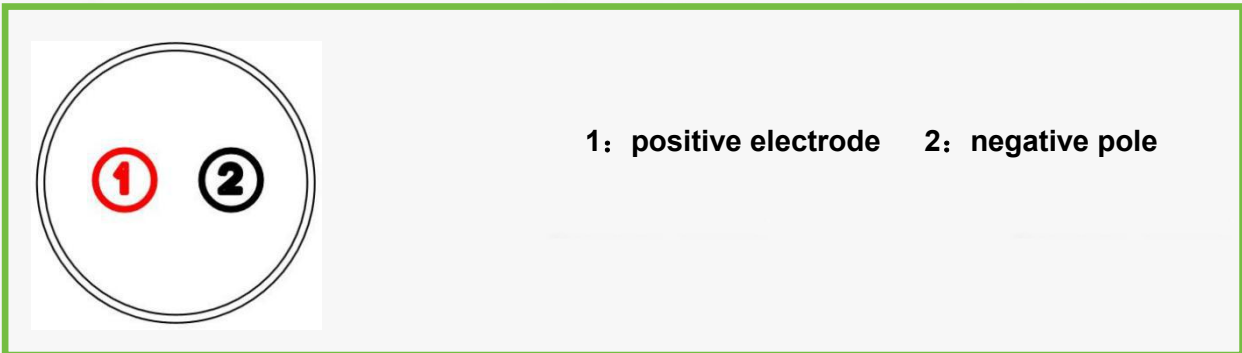

**RS232 DEFINITION OF SIGNAL INTERFACE**

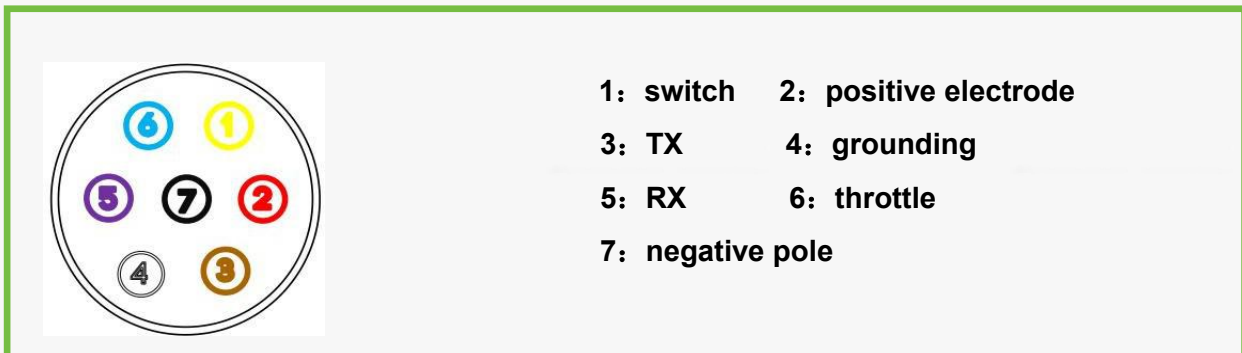

## RS422 DEFINITION OF SIGNAL INTERFACE

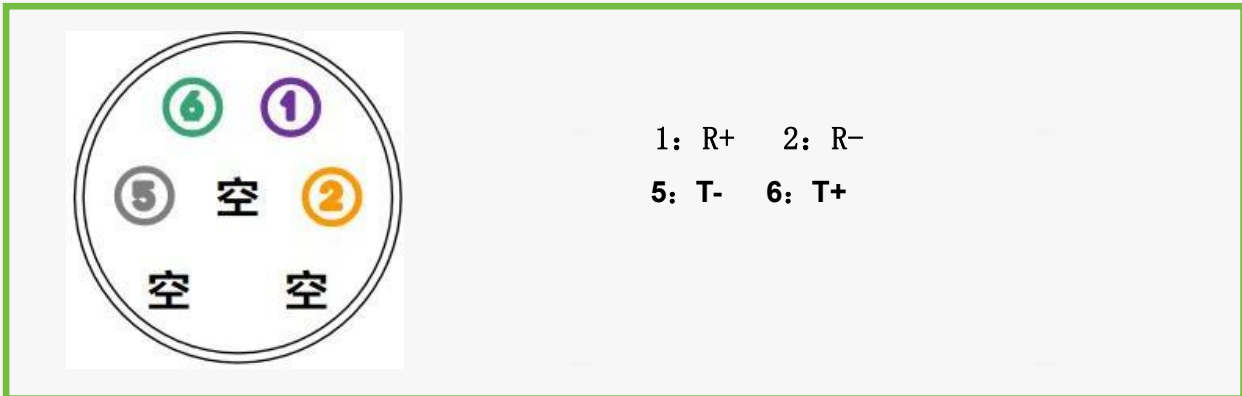

*note: unless otherwise specified, the default ecu interface for sw800pro-y engine is defined as rs232, communication protocol zk, and baud rate 9600. if you need rs422 interface definition, please contact swiwin after-sales personnel to purchase.*

### 5.4 REGARDING THE CONTROL PROTOCOL

#### 1. throttle signal

*the throttle adopts a pulse width (pwm) control method, with a pulse width of 1ms~2ms. 1ms corresponds to the minimum throttle (0%), 2ms corresponds to the maximum throttle (100%), and the pulse high level is 3.3v and 5v (3.3v and 5v are available on average), while the pulse low level is 0v.*

#### 2. start switch

*the startup switch adopts a pulse width (pwm) control method, with a pulse width of 1ms~2ms. 1ms corresponds to off and 2ms corresponds to on. the pulse high level is 3.3v and 5v (3.3v and 5v are available on average), and the pulse low level is 0v.*

#### 3. remote control data

① *the engine has telemetry function and transmits data through a 232 standard serial port with a baud rate ranging from 9600bps~57600bps.*

② *the data to be measured includes but is not limited to engine speed, engine throttle, fuel pump voltage, engine status, and error messages.*

③ *to test the communication protocol openness of the data, provide detailed communication protocol documentation.*



#### 4.data record

- ① The engine has a data recording function, which can record data from 2 hours before the engine failure.
- ② The data recording content includes but is not limited to engine speed, engine throttle, oil pump voltage, engine status, and error messages.
- ③ Provide engine data analysis software for post flight data analysis.

### 5.5 ENGINE CONNECTION INSTRUCTIONS FOR DIFFERENT STARTING MODES

use the remote control to start the connection method (the receiver, battery, remote control, and computer need to be provided)

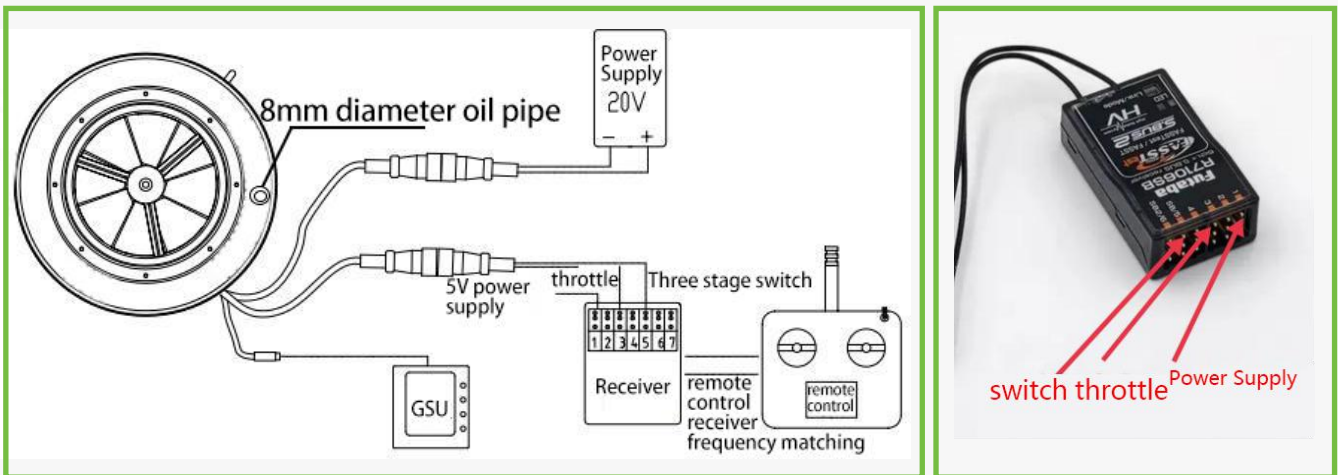

1. connect the engine power cord to a 20v dc power supply.
2. the remote control receiver determines the throttle and switch channels based on frequency.
3. the engine signal line is connected to the receiver through a signal adapter, paying attention to the corresponding channel.
4. connect the engine data cable to the display.
5. connect the power supply to the engine and receiver.
6. test all engine functions according to the pre start testing requirements in 6.4.
7. calibrate remote control:
  - ① turn on the power switch of the remote control and open the throttle lock (three-stage) of the remote control.



② select "calibrate remote control" on the gsu homepage ->click the "ok" button ->select "maximum" ->turn the throttle to maximum ->click "ok" to complete the maximum speed calibration; select the "standby" option, turn off the throttle to the minimum, and click "ok" to complete the idle calibration.

③ close the remote control throttle lock (three-stage). turn off the throttle to the minimum and click "ok" to complete the minimum speed calibration.

8. start the engine and observe its operating status. the starting process of the engine is as follows: after starting, the starter motor starts working first, and when the speed reaches around 800 revolutions per minute, the igniter starts working. at this time, the display shows a high current of about 10a. when the speed reaches 1300 revolutions per minute, the ignition solenoid valve opens. after 0.5 seconds, the ignition oil pump starts working. at this time, a continuous flame is sprayed from the engine tailpipe, and the gsu displays a continuous temperature rise. the ecu determines that the engine ignition is successful. when the speed rises to 2500 rpm, the main solenoid valve intermittently opens, the main oil pump starts working, and the engine enters the preheating stage. when the speed reaches around 7000 rpm, the ignition solenoid valve and ignition oil pump stop working. when the speed reaches 13000 rpm, the starter motor stops working. when the speed reaches 25000 rpm, the engine reaches idle and the start is successful. afterwards, the engine does not require onboard battery power and can generate electricity autonomously, with a maximum output voltage of approximately 50v.

## ACTIVATE CONNECTION MODE USING RS232/422 COMMUNICATION PROTOCOL

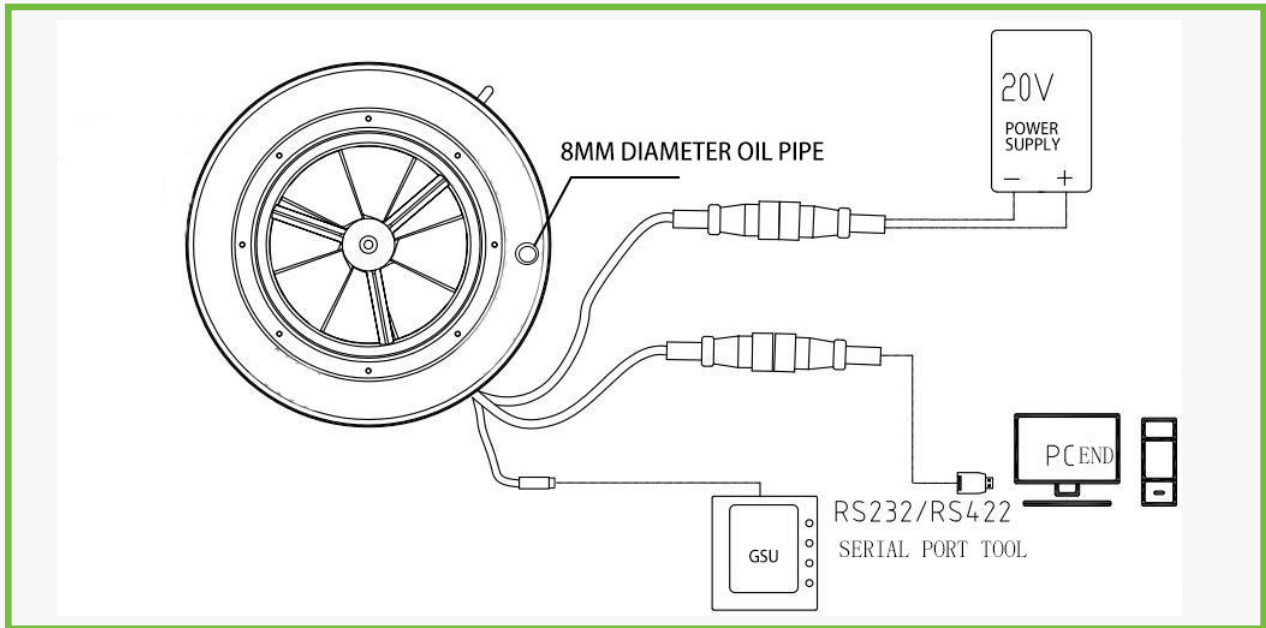

1. connect the engine power cord to a 20v dc power supply.
2. the engine signal line is connected to the computer through an rs232/422 serial port tool.
3. open the ecuctrlzk software. check if the com port is selected correctly, check the baud rate (default is 9600), stop bit 2, and protocol version as numbers, such as 2 and 4. if the numbers are not displayed, please install or upgrade the serial port tool driver on a computer with a network connection. click on 'throttle control' again.

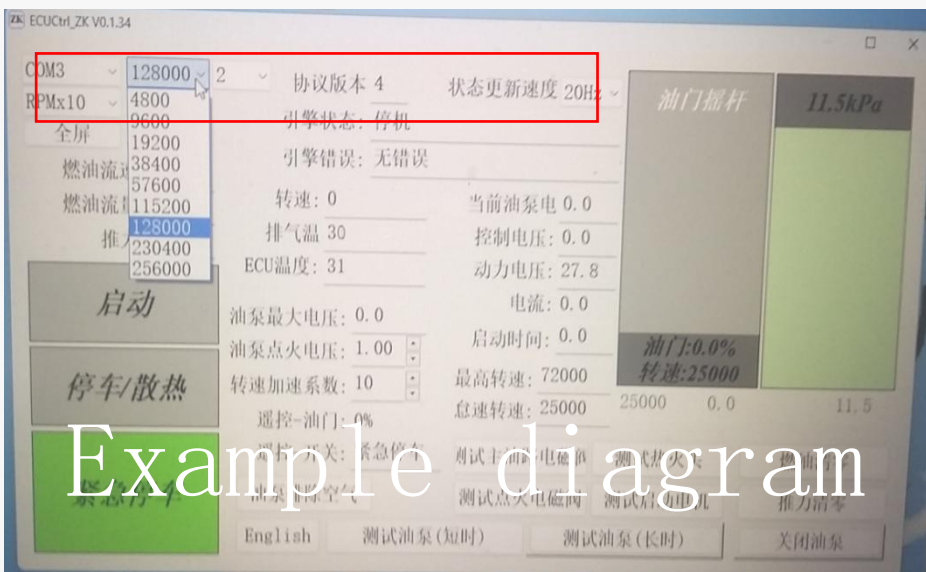

4. test all engine functions according to the pre start testing requirements in 6.4.

5. one click engine start: click "start" to start the engine ignition and operation. observe the operating status of the engine. the starting process of the engine is as follows: after starting, the starter motor starts working first, and when the speed reaches around 800 revolutions per minute, the igniter starts working. at this time, the display shows a high current of about 10a. when the speed reaches 1300 revolutions per minute, the ignition solenoid valve opens. after 0.5 seconds, the ignition oil pump starts working. at this time, a continuous flame is sprayed from the engine tailpipe, and the gsu displays a continuous temperature rise. the ecu determines that the engine ignition is successful. when the speed rises to 2500 rpm, the main solenoid valve intermittently opens, the main oil pump starts working, and the engine enters the preheating stage. when the speed reaches around 7000 rpm, the ignition solenoid valve and ignition oil pump stop working. when the speed reaches 13000 rpm, the starter motor stops working. when the speed reaches 25000 rpm, the engine reaches idle and the start is successful. afterwards, the engine does not require onboard battery power and can generate electricity autonomously to meet operational needs.

## 5.6 GSU USER MANUAL

### INITIAL INTERFACE OF GSU AFTER CONNECTING THE ENGINE

when the engine is not started, the gsu displays rpm, temp, etc. after the engine is started, the data displayed by the gsu is real-time measured data.

#### GSU SCREEN DISPLAY:

RPM:  
TEMP:  
CURRY:  
PRE:  
PWRVOL:  
PEVVOL: ENGINE MODEL  
TIME: ACC:  
STATE:  
COLUMN CHART (RPM,TEMP,PUMP,RC)



note:

①acc represents the acceleration time from idle to 100% maximum speed, measured in seconds;

②the oil pump value is the output voltage multiplied by 1000. for example, if the maximum speed output is 4.0v, it will display 4000;

③the temperature unit can be switched between celsius or fahrenheit and has calibration function;

### ECU SETTING INTERFACE

press the ok button to enter the settings directory. the data in the upper part of the display screen is the last run record, and the settings interface is below.

it is divided into nine parts: engine start-up, engine operation, remote calibration, starter motor, engine cooling, other settings, test settings, data charts, language settings, etc.press the "+" and "-" buttons to manually select from nine options.

GSU SCREEN DISPLAY:  
 RUN INFORMATION  
 TOTAL TIME:  
 CYCLE:  
 STOPRPM:  
 STOPTEMP:  
 MAXRPM:  
 SETTING  
 STARTUP, RUNNING,STUDY RC,  
 STARTER,COOLING,OTHER,TEST,  
 DATACHART,LANGUAGE

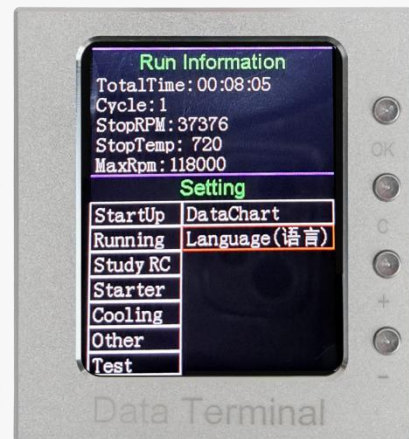

## ENGINE STARTUP SETTINGS

*when the engine startup option is selected, press the ok key to enter the startup parameter setting interface. press the plus sign "+" and minus sign "-" to select various parameter options, press the ok key to select the option, and then press the plus sign "+" and minus sign "-" to set the size and value of the parameters. the meaning represented by each parameter is as follows:*

- pump voltage: the driving voltage of the oil pump during ignition. if the oil pump cannot rotate smoothly or waits for too long to rotate during each ignition, increase this value. control the oil output during startup, the higher the voltage, the more oil is supplied during startup.*
- rpm startup ramp: refers to the slope of the increase in starting motor speed during the period from ignition to clutch disengagement. the higher the slope, the faster the speed increase.*
- pump startup ramp : adjust the fuel supply slope between clutch disengagement and idle speed; it refers to the fuel supply slope of the oil pump during the engine start-up phase. the higher the slope value, the greater the fuel supply.*
- glow plug: the voltage value supplied to the ignition head during engine ignition generally does not exceed 7v. when the weather is cold or the ignition only emits smoke without igniting, it is because the temperature of the ignition head is not high enough. you can try to slightly adjust it by 0.2v each time, and the maximum cannot exceed 7v. adjusting it arbitrarily can easily cause overheating and shorten the life of the ignition head;*
- valve: when the engine is ignited, it controls the amount of oil in the ignition oil circuit. the higher the oil threshold, the longer the opening time, and the more fuel is supplied.*
- ignition RPM: when the ignition speed is reached, the engine starts to ignite, the hot head lights up, and the ignition program enters.*
- prehea rpm: when the engine reaches the preheating temperature, the engine speed increases to the preheating speed and enters the preheating program.*

➤rpm off starter: when the specified disengagement speed is reached, the starter motor clutch will disengage from the spindle clutch. speed: when the specified disengagement speed is reached, the starter motor clutch will disengage from the spindle.

GSU SCREEN ISPLAY:  
START-UP  
PUMP VOLTAGE:  
RPM STARTUP RAMP:  
PUMP STARTUP RAMP :  
GLOW PLUG:  
VALVE:  
IGNITION RPM:  
PREHEA RPM:  
RPM OFF STARTER:

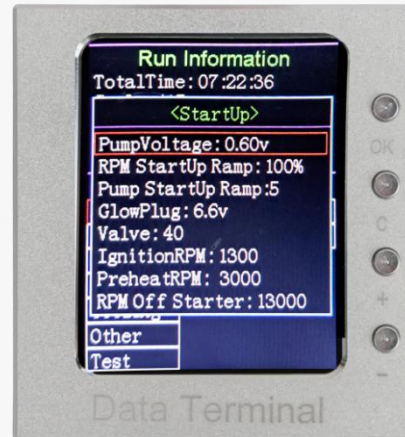

#### **ENGINE OPERATING PARAMETER SETTING INTERFACE:**

press the c key from the previous interface to exit and enter the settings directory interface. press the plus "+" and minus "-" keys to select the engine running and enter the engine running parameter setting interface below. press the plus sign "+" and minus sign "-" to select various parameter options, press the ok key to select the option, and then press the plus sign "+" and minus sign "-" to set the size and value of the parameters. the meaning represented by each parameter is as follows:

- rpm acc: the higher the acceleration value, the faster the fuel supply slope and the faster the acceleration time.
- rpm dec: the higher the deceleration value, the faster the oil collection slope and the faster the oil collection time.
- max rpm: the maximum rpm value reached by the engine setting.
- idle rpm: the standby speed value set by the engine.
- min rpm: below the minimum speed, the ecu defaults to engine shutdown.
- max temp: temperature protection value. when the temperature exceeds the maximum temperature, flameout protection will be implemented.



- low colt: when the voltage falls below the minimum value, the engine will issue a low voltage alarm.
- restart glow plug: the ignition voltage during automatic startup.
- puml imit: after reaching the specified limit value, the oil pump value will not increase.

GSU CREENDISPLAY:  
ENGINE RUNNING  
RPM ACC:  
RPM DEC:  
MAX RPM:  
IDLE RPM:  
MIN RPM:  
MAX TEMP:  
LOW COLT:  
RESTART GLOW LUG:  
PUML IMIT:

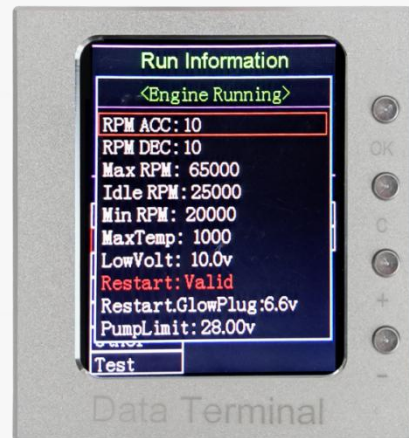

## REMOTE CONTROL OPERATION CALIBRATION LEARNING INTERFACE

press the c key from the previous interface to exit and enter the settings directory interface. press the plus "+" and minus "-" keys to select the calibration remote control and enter the remote control operation calibration learning parameter setting interface below. press the plus sign "+" and minus sign "-" to select various parameter options, press the ok key to select the option, and then press the plus sign "+" and minus sign "-" to set the size and value of the parameters. the meaning represented by each parameter is as follows.

- set the throttle stroke from this menu, and futaba's remote control must set the throttle channel to reverse phase;
- max: indicates the highest throttle, maximum throttle, highest fine adjustment
- idle: indicates idle throttle, minimum throttle, maximum fine adjustment
- failsatetime: indicates turning off the accelerator, minimum throttle, and minimum fine adjustment

➤ *protocol: the factory setting is zk. if you have any special requirements, please contact swiwin after-sales personnel*

➤ *uart-band rate: the factory setting is 9600, which can be adjusted according to customer requirements*

➤ *uart-stop bit: the factory setting is 2, which can be adjusted according to customer requirements*

GSU THE SCREEN WILL DISPLAY:

RC STUDY

MAX:

IDLE:

FAILSATETIME:

PROTOCOL:

UART-BAND

RATE:

UART-STOP BIT:

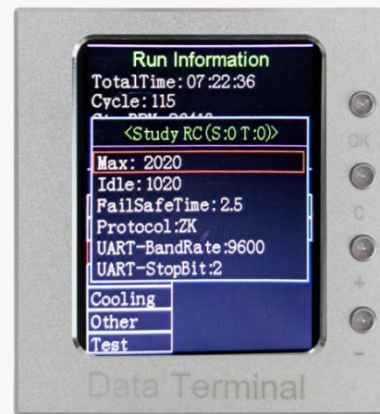

### STARTING MOTOR PARAMETER SETTING INTERFACE:

➤ *eject time: control the time for the starter motor to pop up the clutch*

➤ *eject voltage: the voltage value when the clutch is disengaged.*

➤ *run voltage: the voltage value at which the motor operates normally during the start-up phase.*

➤ *rpm stable: when starting, the speed will not have a significant up and down fluctuation stabilizing effect.*

GSU THE SCREEN WILL DISPLAY:

START

EJECT TIME:

EJECT VOLTAGE:

RUN VOLTAGE:

RPM STABLE:





## ENGINE COOLING PARAMETER SETTING INTERFACE:

press the c key to exit from the previous interface and enter the settings directory interface. press the plus "+" and minus "-" keys to select engine cooling and enter the engine cooling parameter settings interface below.

rpm: after the engine is turned off normally, the starter motor will run to cool the engine until it reaches room temperature. the rotational speed refers to the operating speed of the starting motor during cooling.

GSU THE SCREEN WILL DISPLAY  
RPM:



### REMARKS:

① set the cooling speed after normal shutdown, and stop cooling when the engine automatically cools down to 80 °C after normal shutdown. cooling is the continuous operation of the starter motor, as the ecu cannot determine whether there is a fire condition in case of accidental shutdown. therefore, if the shutdown is not normal, it will not automatically cool down;

② when the engine unexpectedly stalls, it is also necessary to cool down as quickly as possible to protect the engine. at this time, manual cooling can be used by placing the fine adjustment at the lowest position and pushing the throttle to the highest position to perform manual cooling;

③ if the temperature is above 80 °C during startup, it will also be cooled first until the temperature drops below 80 °C before starting;

**OTHER PARAMETER SETTING INTERFACE:**

press the c key to exit from the previous interface and enter the settings directory interface. press the plus sign "+" and minus sign "-" keys to select other parameters and enter the other parameter settings interface below. press the plus sign "+" and minus sign "-" to select various parameter options, press the ok key to select the option, and then press the plus sign "+" and minus sign "-" to set the size and value of the parameters.

the meaning represented by each parameter is as follows:

battery reset: after the test is completed, reset all the battery used in the ecu to zero (for recording purposes)

adjust temperature: adjust according to the environment.

oil pump type: adjust according to the oil pump used.

software version: latest

GSU THE SCREEN WILL DISPLAY:  
 CLEARBATUSED:  
 ADJUSTTEMP:  
 TEMPERATURE UNIT:  
 TEMPTYPE:  
 ECU-VER VERSION:  
 GSU - VER:



**TEST PARAMETER SETTING INTERFACE:**

press the c key to exit from the previous interface, enter the settings directory interface, select the test by pressing the plus "+" and minus "-" keys, and enter the test parameter settings interface below. press the plus sign "+" and minus sign "-" to select from various parameter options, and press the ok key to select the option. the testing function is to test whether certain hardware can work properly.

GSU THE SCREEN WILL DISPLAY:

- TEST ENGINE
- TEST FUEL PUMP
- TEST IGNITI PUMP
- TEST FUEL VALUE
- TEST GAS VALUE
- TEST GLOWPLUG
- TEST STARTER

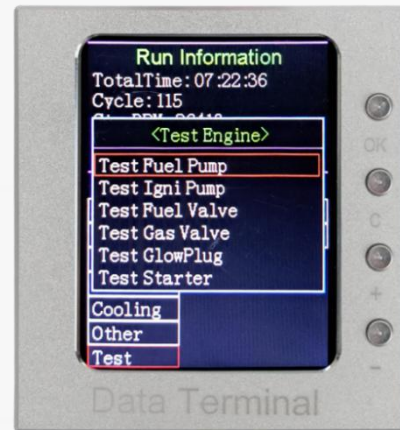

### DATA CHART DISPLAY INTERFACE:

*data chart: record the status of engine start-up and operation. different colored curves represent different meanings. green represents speed, red represents temperature, light blue represents oil pump, and blue represents voltage.*

GSU THE SCREEN WILL DISPLAY:

- DATA CHART (CURVE CHART AREA)
- RPM (GREEN TEXT):
- TEMPE(RED TEXT):
- PUMP (LIGHT BLUE):
- COOLING (WHITE TEXT):
- PWRVOL (DARK BLUE TEXT):
- RC (YELLOW TEXT):



### SET LANGUAGE INTERFACE:

*by selecting, the monitor can be set to different languages such as english, simplified chinese, traditional chinese, and spanish.*

GSU THE SCREEN WILL  
DISPLAY:  
SET LANGUAGE  
ENGLISH  
中文 (简体)  
中文 (繁体)  
Español  
SPANISH  
RESET CONFIG



### TEMPERATURE CORRECTION

*during the engine start-up process, the ecu controls the engine operation by judging the built-in temperature sensor. if the temperature sensor inside the engine differs significantly from the ambient temperature, it will affect the ecu's judgment and require the use of gsu for temperature calibration of the engine.*

on the gsu main interface, select "other"



select 'adjust temp' and click '+-' to adjust the temperature up and down, keeping the corrected temperature consistent with the ambient temperature.



## 6. ENGINE DEBUGGING

### 6.1 ENGINE ASSEMBLY

*the sw800pro-y engine adopts an integrated design of engine body, ecu, and tcu, which is easy to install and use. this engine is a precision instrument composed of high-precision components.*

*each new machine undergoes strict dynamic balancing, bare machine testing, and whole machine testing before leaving the factory, and the test results are recorded. the test results of the entire machine will be shipped together with the engine in the form of an "engine operation sheet".*

### 6.2 engine test run

## 6.2 REQUIREMENTS FOR VENUE AND FACILITIES

**6.2.1 Requirements for Venue and Facilities***you need to meet the following conditions to conduct engine testing:*

- 1) equipped with a fixed 80kg thrust engine fixture, the engine is securely fixed.*
- 2) a well-equipped testing space, or an open outdoor space, where there should be no vegetation cover, foreign objects, debris, or large dust in the hazardous area during engine operation.*

## 6.2.2 BRIEF FLOWCHART OF GROUND TESTING (SIMILAR TO THE RS232/422 SERIAL PORT TOOL TEST)

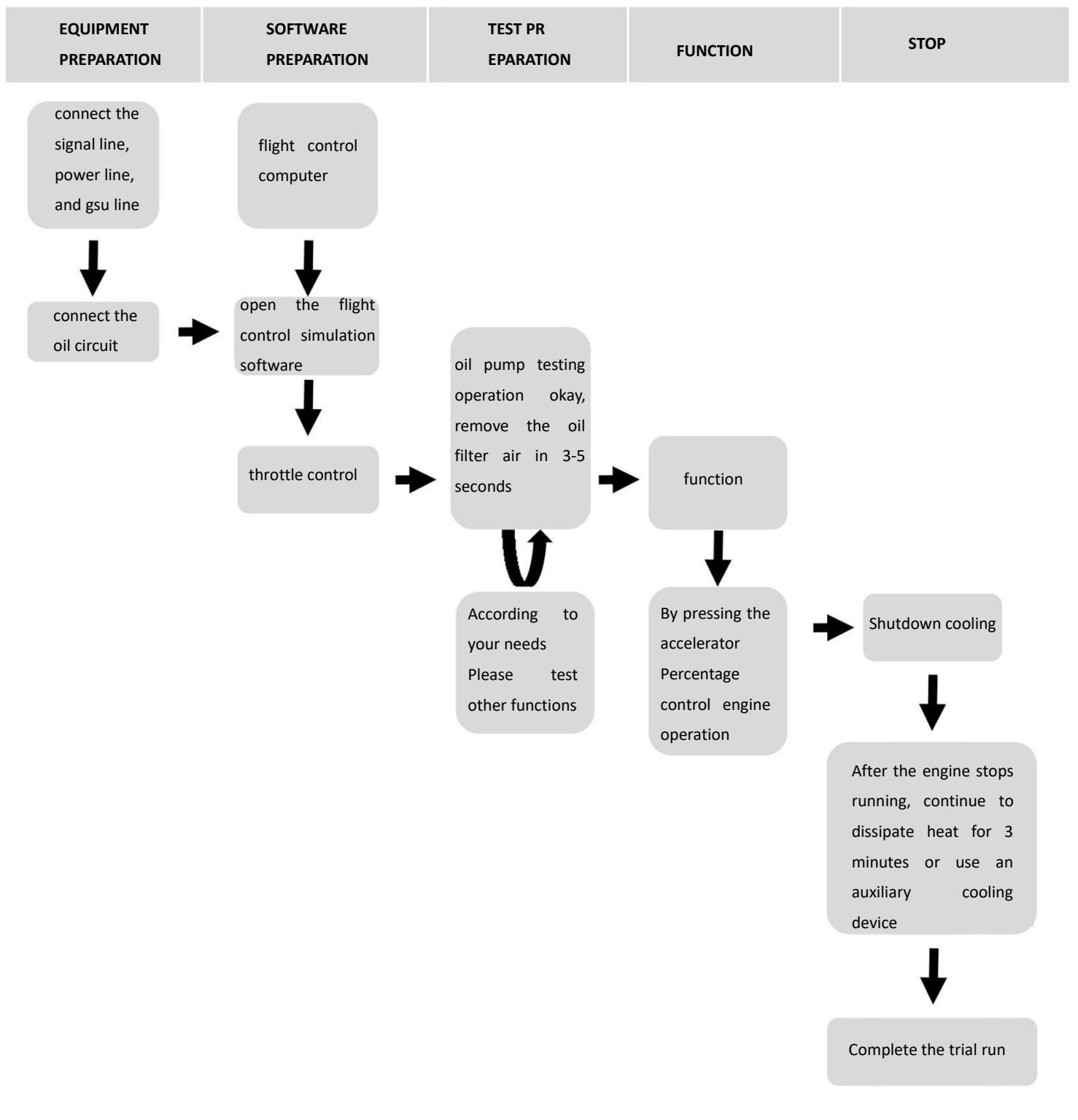

### **6.3 ENGINE INSTALLATION**

*the external dimensions and installation of the engine are detailed in the engine dimension diagram.*

*please note that the overall dimensions do not include external engine parts. before installation, sufficient allowance should be left and operated carefully to ensure that the external temperature sensor (**temperature sensing sensor**) is not damaged.*

### **6.4 PRE STARTUP TESTING**

*after the engine installation is completed and all wiring harnesses are connected, use the display to test the main oil pump and exhaust the air inside the oil pipe on the testing function interface. press and hold the ignition solenoid valve again to test the ignition. at this point, the ignition oil pump starts for about 3 seconds. if you hear a significant decrease in the speed of the ignition oil pump (due to the ultrasonic resistance of the fuel to the oil pump gear), it is judged that the ignition oil pump is in its optimal operating state. test the starter motor (rotating the impeller clockwise), test the ignition head (two red dots visible from the tail nozzle inward), and test the solenoid valve (audible clattering sound). if the tested components are working properly, the startup test can be carried out.*

### **6.5 SAFETY**

*the testing site and equipment meet the requirements, pay attention to personnel safety, and start the test (see safety instructions for details).*



## 6.6 ENGINE OPERATION PROCESS DIAGRAM

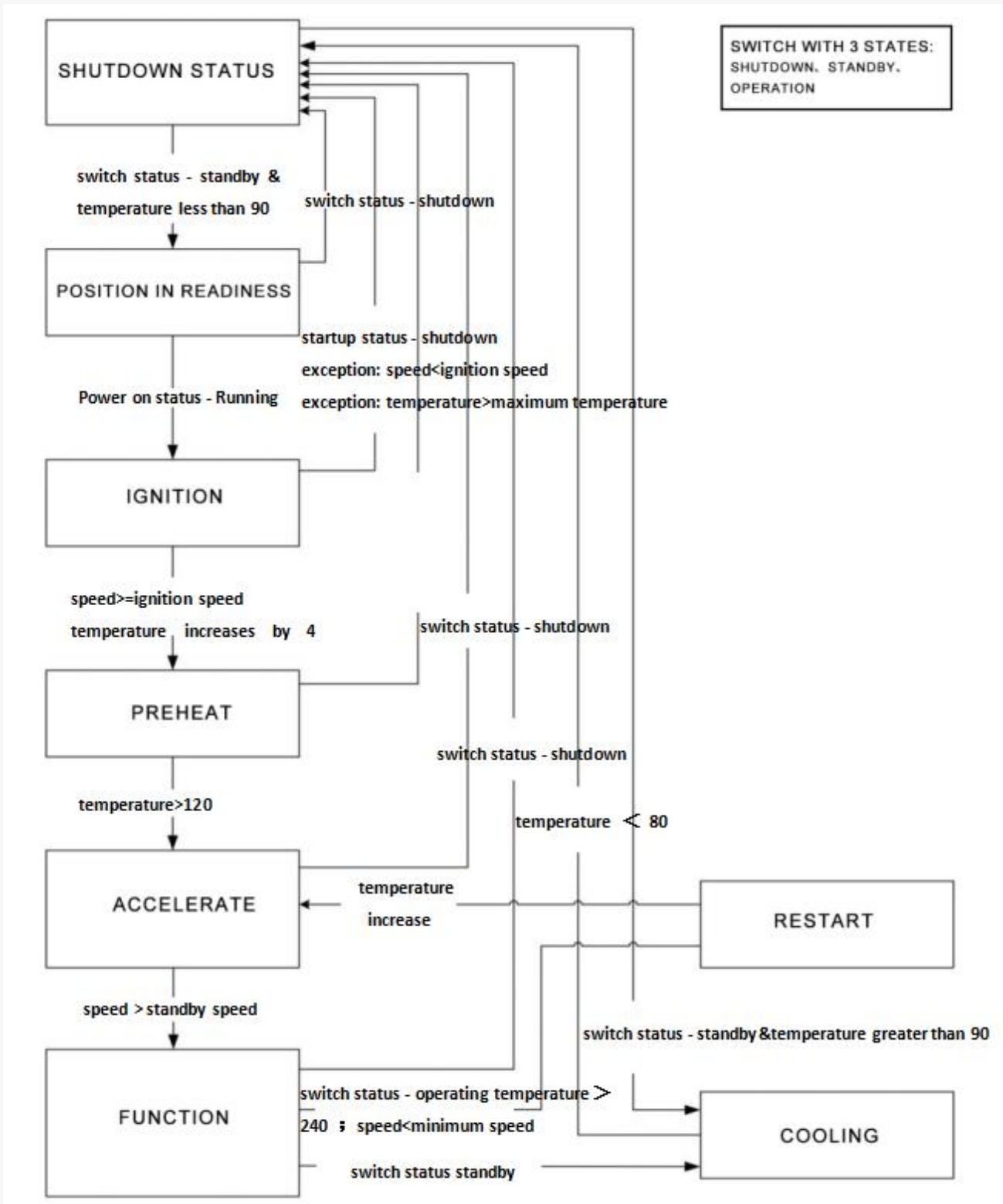



## 7.PARAMETERS RELATED TO ENGINE STARTUP AND OPERATION

The following are the parameters related to engine start-up, which have been set at the time of the engine leaving the factory. You can refer to these data when using the product.

supply voltage	20V
ignition voltage	3.6V
motor slope	100
pump start up ramp	3
glow plug	6.6V
duty cycle of solenoid valve	40
ignition rpm	1300rpm
preheat rpm	3000rpm
rpm off starter	13000rpm
pop-up time	0.8s
ejection voltage	5V
run voltage	2.5V
rpm stable	20
rpm acc	10
rpm dec	10
max rpm	65000
idle rpm	25000
minimum speed	20000
max temp	1000℃
low volt	10V
restart	close
restart glow plug	consistent with the voltage of the burner
pump limit	28V
idle stable	5-8

*note: all parameters of the engine have been set before leaving the factory, please do not change them arbitrarily. if you have any special needs or questions, please contact swiwin after-sales service personnel.*

## 8.FREQUENTLY ASKED QUESTIONS

### 8.1COMMON PROBLEM ELIMINATION

problem description	cause analysis	exclusion measures
startup failed	1. check the voltage setting of the oil pump and observe whether the working status of the oil pump body is stuck. check the oil discharge status. check the oil output. adjust the oil pump voltage. 2. check the ignition head and whether the voltage setting is correct. test the ignition head to see if it lights up. 3. test the solenoid valve to see if it is working properly. 4. check if the oil circuit is blocked. 5. check if the ecu parameters are read correctly. 6. check if the oil filter in the oil circuit is blocked. 7. check if the tcu is intact. 8. check if the speed is abnormal. 9. check if the ground wire is connected correctly. 10. check if the screw connection is tight. 11. check if the software is of the appropriate version number.	check whether each oil circuit, pipeline, and wiring is connected correctly and completely. is the battery running low. parameter reset, replace starter assembly, replace ignition head, replace solenoid valve assembly, and tighten screws again.
the ignition head has no current or does not light up	1. check if there is current in the test ignition head of the test project. 2. check if the ignition head lights up when the tail nozzle is out. 3. disassemble the machine and check if the ignition head is broken. 4. check if the insulation tube of the ignition head is broken. 5. check if the ground wire of the ignition head is connected and non-conductive. 6. replace with a new ignition head 7. replace with a new tcu 8. re import parameters	check whether each oil circuit, pipeline, and wiring is connected correctly and completely. replace the ignition head, replace the insulation tube, and upgrade the software again. is the battery running low.

starter malfunction	1. check if there is a burnt smell on the starter motor or if it rotates smoothly by hand. 2. check if the parameters of the starter motor are correct or adjust them. 3. check if the rubber ring of the clutch is abnormal or replace it. 4. check the wear status of the clutch and replace it immediately if it is severely worn. 5. check the software version. 6. check if the tcu parameters are correct.	check whether each oil circuit, pipeline, and wiring is connected correctly and completely. is the battery running low. replace the starter assembly, clutch, and parameters.
long startup time	1. check if the oil pump is smooth or stuck. 2. check the ignition temperature and ignition confirmation temperature. 3. check if the heating time is 7 seconds. 4. check if the oil circuit is smooth. 5. check if the solenoid valve works smoothly. 6. check if the temperature rises and if it increases. 7. check if the connections of each circuit are correct.	check if there is fuel in the fuel pipe and if the fuel pump is working. replace the oil pump, replace the ignition head, replace the solenoid valve, and replace the temperature sensing probe. is the battery running low.
engine starts and sprays a large flame	1. check if the parameter settings of the solenoid valve and oil pump are correct. 2. check if the oil pump matches the engine. 3. check if the oil circuit is connected incorrectly. 4. check the solenoid valve gasket	replace the oil pump, check the parameters, reconnect the oil circuit, or replace the solenoid valve. reduce the voltage of the oil pump.
the temperature does not rise when the engine is ignited	1. check if the temperature probe is damaged. 2. check if the oil circuit is flowing smoothly. 3. check if the temperature probe is connected incorrectly. 4. check if the battery is running low.	replace the temperature sensing probe and reconnect it. reduce the voltage of the oil pump. replace the oil pump.
unable to reach full speed	1. engine oil leakage 2. incorrect use of oil pump 3. current limitation 4. oil pump power limitation 5. whether the oil circuit is blocked	increase oil pump parameters, replace oil pump, check for oil leakage. replace oil circuit or solenoid valve, replace oil pump and pipeline.
slow acceleration time	1. insufficient combustion in the combustion chamber 2. defects in the nozzle ring 3. unsmooth oil circuit 4. stuck oil pump 5. low acceleration curve	replace the combustion chamber, replace the nozzle ring, change the acceleration curve value, and replace the oil pump.

power overload	1. circuit board failure 2. welding harness short circuit 3. the spindle and starter motor are not concentric 4. the harness is damaged 5. the front outer cover is deformed	check each circuit and replace the battery.
engine vibration	1. check if the connections of each component are tight. 2. check if the engine balance is within the process requirements. 3. check if the screws of the compressor wheel and rear turbine are tight. 4. check if the bearings are damaged. 5. check if the compressor wheel and rear turbine are cracked or chipped. 6. check if there are any foreign objects in the shaft tube	replace the bearings, replace the compressor and rear turbine, replace the shaft tube, tighten all screws and components
engine stalling	1. is the nozzle ring abnormal? 2. is the oil pump stuck? 3. is the solenoid valve not open and holding? 4. tcu fault. 5. blockage in the oil circuit. 6. no oil in the fuel tank. 7. unstable voltage. 8. short circuit in the power supply. 9. engine suction of foreign objects. 10. engine affected by airflow	replace the nozzle ring, replace the oil pump, replace the tcu, and replace the power supply. spin the nozzle ring.
engine chip loss	1. compressor blade falling off 2. rear turbine blade falling off 3. foreign objects entering the engine intake 4. high temperature 5. speed exceeding the specified speed 6. loose screws 7. nozzle ring falling off 8. oil needle or internal engine screws falling off and hitting the blades 9. material defects inside, such as sand holes, cracks, fractures, air holes, etc.	replace the compressor or replace the rear turbine
acceleration anomaly	check if it is normal for the clutch to reach the disengagement speed after starting the engine	reduce the speed slope or increase the slope of the oil pump. check the battery voltage.
engine entering the soil	check the engine body. check the bearings of the compressor and expander.	disassemble the engine, replace the oil needle, replace the solenoid valve assembly, replace damaged components such as bearings. clean up the soil residue inside again. rebalance the test machine.

cannot ignite, temperature does not rise	check if the ignition head of the engine is abnormal, check if the temperature sensing probe is working properly, clean the ignition oil circuit, and check if the oil delivery is smooth.	clean the oil circuit and test the temperature sensing characteristics of the temperature sensing probe. installation testing.
gsu shows engine not found	check the version of gsu and replace it for testing. check the connection status of the circuit, check if the wiring harness is normal, and check if the ecu is normal.	gsu upgrade, repair ecu circuit board, remove capacitors. test the engine again.
engine idling and stalling	check if the engine oil pump is stuck, check if the tcu and speed are abnormal, and check if the oil circuit is smooth.	replace tcu, replace oil pump
engine water ingress	check each component, such as bearings, shaft tubes, compressor wheels, and inspect tcu and ecu	replace bearings, shaft tubes, compressor wheels, replace tcu ,ecu
cannot start normally, cannot preheat after startup	check the starter motor, clutch, spindle, and the wiring harness of the motor for normal operation	replace the starter assembly and retest the engine
shell deformation, tail nozzle deformation	check the operation records of the ecu and verify if there are any abnormalities in the rear turbine of the compressor. check if the screw holes at the connection position of the shell are abnormal, and check if the screw holes at the connection of the tailpipe are abnormal	replace the casing, replace the tailpipe, and replace any abnormal screw hole components.
when starting, the display has current but cannot ignite	1. check if the spindle is rotating. 2. check if each wire harness is short circuited. 3. check if the battery is leaking	repair the starter motor or spindle, repair various circuits or replace the battery.

## 8.2 ECU ERROR FAULT ANALYSIS

during the operation of the engine, if there is a signal malfunction, the ecu will automatically report an error. the following table explains these faults.

error name	explain
overtime	1. during ignition: temperature remains unchanged for 20 seconds 2. forced cooling: time exceeding 60 seconds
low battery voltage	1. the voltage of the power battery is lower than the minimum value (the minimum value can be modified) 2. the voltage of the remote control receiver is lower than 4v
fire head malfunction	1. no flame current detected
abnormal oil pump	1. unable to connect to the oil pump motor controller (only supported by brushless motor version)
starting motor malfunction	1. during ignition: the engine speed cannot reach the ignition speed
low rotational speed	1. during ignition: the engine speed drops to 50% of the ignition speed 2. during preheating: the engine speed drops below the ignition speed 3. during acceleration: the engine speed drops below the warm-up speed 4. during operation: the engine speed is lower than the set minimum speed
unstable rotational speed	1. during acceleration: engine rpm fluctuates up and down 2. during acceleration: the engine speed drops significantly
high temperature	1. during ignition: the exhaust temperature is greater than the set maximum temperature value 2. during preheating: the exhaust temperature is

	greater than the set maximum temperature value 3. during acceleration: the exhaust temperature is greater than the set maximum temperature value for 4 seconds
--	-------------------------------------------------------------------------------------------------------------------------------------------------------------------

## 9. COMPATIBILITY

*if using zk or flight control software to control the engine, the connection between the engine and your device involves compatibility issues.*

### 9.1 COMPATIBILITY OF SERIAL PORT ADAPTER CABLE CONNECTORS

NAME	PERFORMANCE INDEX	COMPATIBILITY
RS232 ADAPTER YHL-B232	USB2.0,COMPATIBLE USB1.1  SUPPORT RS232 THREE WIRE  SERIAL PORT INTERFACE  USB BUS FOR DIRECT POWER SUPPLY WITHOUT THE NEED FOR AN EXTERNAL POWER SOURCE  EQUIPPED WITH A SET OF 5V/500MA POWER OUTPUTS	SUPPORT COMPUTER SYSTEMS :  WINDOWS2000、WINDOWSXP、WINDOWS SERVER 2003 (32、64 位)/VISTA/WINDOWS 7 (32、64 位)、WINDOWS 8、WINDOWS10

### 9.2 UPGRADER COMPATIBILITY

NAME	PERFORMANCE INDEX	COMPATIBILITY
UPGRADER (ZK-LINK V1.4)	-----	SUPPORT COMPUTER SYSTEMS :  WINDOWS7、WINDOWS 8、WINDOWS10

## 10. STORAGE AND LUBRICATION

*all models of engines from swiwin company can use kerosene or diesel as fuel, and are mixed with 3% -5% lubricating oil. this mixed lubricating oil is also used in the bearing lubrication system, and it is recommended to use swiwin brand or mobil pegasus no.2 lubricating oil.*

*the engine has been stored for more than 3 months. to prevent bearing corrosion, it is recommended to lubricate the engine thoroughly with fuel, place it vertically, and seal it with a sealed bag. if there are ground testing conditions, ignition testing can provide better maintenance for the engine. if necessary, you can also contact after-sales personnel to return to the factory for maintenance.*

## 11. ENGINE MAINTENANCE AND UPKEEP

*the maintenance requirements and cycle of the product, including cleaning, replacement of parts, etc.*

*1. maintenance plan: regularly inspect and replace lubricating oil, air filters, and other components of the engine.*

*2. daily maintenance: regularly check the fastening of various connecting parts and pipelines of the engine, and clean the surface of the engine.*

*3. troubleshooting: if encountering problems such as decreased engine performance or abnormal noise, follow the maintenance manual and troubleshooting process for operation.*

*every hour of engine operation, please check the following:*

- is there any burning or discoloration on the engine casing.*
- is the engine mount intact.*
- is the air inlet and impeller intact.*
- is there any leakage in the oil system and is the oil filter clogged.*
- bearing: manually rotate the rotor and carefully distinguish the bearing sound. if there is a "rustling" sound, the bearing may be slightly damaged due to impurities or improper cooling.*





*it is recommended to use clean fuel or replace the oil filter. if the bearings are clearly damaged after inspection, it is prohibited to use the engine again. you can log in to the swiwin official website and contact after-sales personnel to replace the bearings.*

*maintenance cycle: the regular maintenance cycle for the model version engine is **25 hours per accumulated operating time.***

## **12. AFTER SALES SERVICE**

### **limited liability warranty**

*the service life of a turbojet engine is directly related to the operating environment and operating techniques. the turbojet engine uses the simplest structure to achieve the most extreme working state, and each component is designed and produced to the extreme. the working conditions are extremely harsh. do not disassemble the intake duct and main shaft structure by yourself. once the turbojet engine is disassembled, it must be precisely reinstalled according to specifications to achieve its original performance. random assembly will cause the turbojet body to lose balance, and high-speed operation will cause serious consequences.*

*buyers of new swiwin engines are entitled to a one-year or 25 hour natural damage warranty. if you encounter any questions or operational issues during use, please contact the sales department.*

*if you need the engine to be returned to the factory for maintenance and repair, please log in to the official website of swiwin company <http://www.swiwin.com> or "swiwin power" official account to contact customer service, fill in the engine maintenance application form, and prepare the following relevant contents:*

ENGINE MAINTENANCE APPLICATION FORM			
NAME		THE DATE OF ISSUANCE	
Shipping Address			
Fault Description	_____ Model:		
Other Service Requirements	<input type="checkbox"/> Technical Consultation <input type="checkbox"/> Engine Maintenance <input type="checkbox"/> Accessories Procurement		

SWIWIN TURBOJET EQUIPMENT CO.,LTD

Tel: 15531598038

Email: swiwin@foxmail.com

Web: <http://www.swiwin.com>

Add: 66 Jianye East Road, High-tech district,  
Baoding, Hebei, China

